

WIRELESS
for the
WARRIOR

The Various Series
No. 13 Beacon Crest

Cover and layout: Louis Meulstee.

Cover illustration: Replica Beacon Crest, Type A (Photo Jan Poortman, PA3ESY).

The cover artwork and layout of this pamphlet was prepared with DTP Serif PagePlus X6, using Arial, AvantGarde, Helvetica and Poppl-Laudatio fonts. Scanned illustrations and photos were enhanced and prepared with Adobe Photoshop Elements. The finished publication was directly converted into PDF format.

First published August 2024, Version 1.00, as a free to download print ready publication.

© Louis Meulstee PA0PCR

Ottersum

The Netherlands

info@wftw.nl

<http://www.wftw.nl>

About this publication.

The 'Beacon Crest' ('Crest' being the combination of the designer's initials: C.E.Ramsbottom and T.R.Smith), was a radio beacon used to home the aircraft of a main parachute landing force to their drop zone using the standard fitted aircraft radio compass. This was devised as an alternative to the Eureka Rebecca system.

These beacons were designed and made in a great urge by 16 Base Workshop REME, located near Salerno, Italy, in July 1944. It would be transported to the drop zone by a small pathfinder parachute force, which would then set up and operate the beacon within a very short time.

The Various Series.

The Wireless for the Warrior 'Various' series is a range of articles on topics not directly related, but within the original scope of WftW website and interest. These can be downloaded from www.wftw.nl, freely copied and distributed, but only in their current form, preferably with mention this website.

Note that the page layout of the Various Series was setup with mirrored pages, primarily intended for double sided (colour) printing, preferably on good quality class A paper.

For previously issued free to download pamphlets see www.wftw.nl.



Aug. 2024



This is the replica of a Beacon Crest, Type A, housed in a ubiquitous No. 19 Set spare valves case. It closely resembles the original beacon, based on a photograph from the Imperial War Museum and the article written by one of the designers.

DATA SUMMARY

Organisation: Royal Electrical and Mechanical Engineers.

Developer/maker: 16 Base Workshops REME in Italy.

Year of Introduction: 1944.

Purpose: Radio beacon marking a drop zone.

Frequency: 1.6-2MHz, MCW. Believed 400Hz tone.

Estimated RF power output: Type A: 6W. Type B: 60W.

Valves Type A: Crystal osc/RF output 807, mod/tone 6J5.

Power supply: 12V DC.

Size (cm) Type A: height 6½, length 5¾, width 6.

Type B: height 8½, length 8½, width 21½.

Homing systems

Since the Eureka/Rebecca system was already available to guide aircraft accurately to a drop zone, one may wonder why the Beacon Crest was developed. This question was not addressed in the original article. It is believed that in mid-1944, there was only a limited supply of British Eureka and American AN/PPN-1 beacons, especially considering the imminent invasion. Furthermore, the corresponding British Rebecca and American AN/APN-2 were not found in numerous aircraft.

Considering that all parachutist transport aircraft, such as the American C-47 Skytrain, had as standard a radio compass which allowed homing to a radio transmitter, a medium power transmitter was all that was needed at the drop zone. This was an ingenious idea, however, not many Army transmitters were capable of operating on the required radio compass frequency (200-1750 kHz). Those available required a large aerial system, were very heavy, not suitable for a parachute drop, and would take much time to set up, which was unacceptable. An improvised portable beacon operating on the high end of the radio compass frequency, which could be carried by a parachutist, devised by the Americans, had a limited range and no identification. And thus commenced the development of the successful REME Beacon Crest.

Beacon Crest

Remarks

The Beacon Crest ('Crest' being a combination of the designers' initials: T.R. Smith and C.E. Ramsbottom), was a radio beacon used to home the aircraft of a main (parachute) landing force to their drop zone using the standard aircraft radio compass.

It might have been 1988 when I was granted, as in previous years, permission to visit the archives of the Royal Electrical and Mechanical Engineers (REME) museum. At that time, doing research for the then proposed Wireless for the Warrior series of books, I came across a folder named 'Beacon Crest'. In this folder was a description of the development of a radio beacon by a REME workshop. This beacon was set up by parachute pathfinder forces before the main airborne landing force. Although this topic was not related to the original purpose of my visit, I regularly came across folders and reports with interesting contents, of which some were scanned for future use. In this case, it seemed unlikely, as there was a description and a circuit diagram, but no illustration or photograph of either beacon. An article published in 'The REME Journal' was the only reference, and because in later years nothing more was found, 'Beacon Crest' came to oblivion. Until June 2024, when I was asked to identify a couple of unknown photos of parachute beacons retrieved from the Imperial War Museum website. Looking carefully, I immediately remembered the Beacon Crest folder from 36 years ago. The unfortunately not very detailed photos revealed both the Beacon Crest Type A, of which twelve were built, and the high-power version Type B, of which only two were made. At that stage, with photographs at hand, it was decided to put all the information together in a WftW 'Various' Chapter, which was assigned to interesting topics, not directly related to the origin of the WftW website.

The first-hand story of the 'Beacon Crest' was already published 55 years ago in 'The REME Journal' by C.E. Ramsbottom, one of the designers. For that reason, no attempt was made to rewrite this article and permission was sought (and granted by the REME Corps Secretary Major (Retd.) Wright-Rivers) to reprint this article as an attachment. Based on this article, an introduction was composed, adding more technical details and building a working replica. In addition, some attention was paid to the actual standard build aircraft radio compass which was used to home to the beacon, and details of issues encountered during the construction of the beacon in 1944.

There is little doubt that these small, crude and hastily developed and built beacons in an improvised REME field workshop played a vital role in the liberation of Southern Europe.



Front panel view of the Beacon Crest, fully operational replica. The only change to the original is that, for practical reasons, it now works on the 80-Meter radio amateur band.

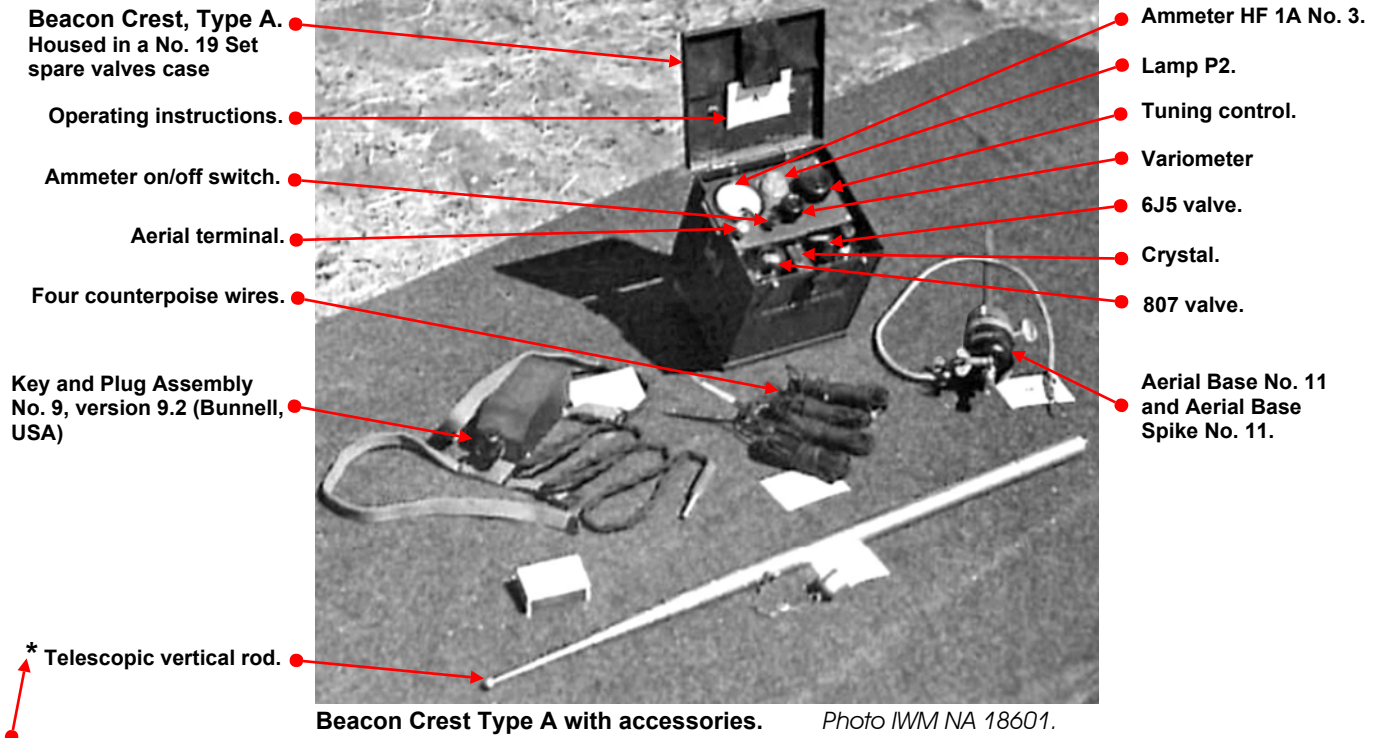

Beacon Crest Type A with accessories. Photo IWM NA 18601.

* It is not certain whether this telescopic vertical rod was actually used in the final design. In lieu, three 4ft. Type F aerial rods might have been used.

OPERATING INSTRUCTIONS FOR BEACON, CREST, TYPE 'A'.

- 1/. ENSURE THAT VALVES AND CRYSTAL ARE PRESSED FIRMLY HOME IN THEIR RESPECTIVE SOCKETS.
- 2/. CONNECT 16/20 -FOOT ROD AERIAL TO FRONT TERMINAL (BRIGHT TOP).
- 3/. CONNECT A GOOD EARTH TO REAR TERMINAL (BLACK TOP).
- 4/. CONNECT 12 VOLT SUPPLY TO SOCKET AT LEFT SIDE OF CASE.
- 5/. ADJUST TUNING CONDENSER (RIGHT HAND KNOB) FOR MAXIMUM BRILLIANCE OF REAR LAMP.
- 6/. ADJUST AERIAL MATCHING (LEFT HAND LEVER) UNTIL FRONT LAMP GLOWS.
- 7/. ALTERNATELY ADJUST TUNING CONDENSER AND AERIAL MATCHING FOR MAXIMUM BRILLIANCE OF FRONT LAMP.
- 8/. TO USE AS KEYED M.C.W. TRANSMITTER, INSERT KEY PLUG IN JACK AT LEFT SIDE OF CASE.

This Operating Instructions card was attached at the inside lid of the Beacon Crest Type A case.

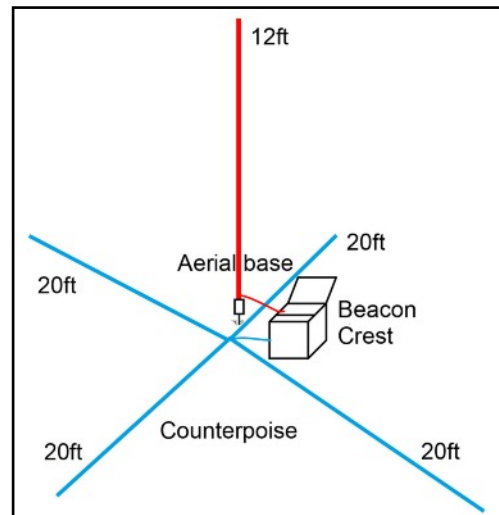

The final aerial design of the Beacon Crest consisted of a vertical 12ft (telescopic) mast. Four counterpoise wires were laid on the ground under the aerial mast. This simple setup allowed the first group of a landing force to operate a beacon in a very short time. Most components were standard issue, apart from the telescopic vertical rod.

Marston matting.

The initial range tests of a Beacon Crest Type A were performed at a local airstrip near Pontecagnono (this might be the current 'Salerno-Costa d'Amalfi' Airport) with the beacon set up close to the Marston mat metal landing strip. These tests carried out with American C-47 aircraft were successful, and had a range of 45 Miles. However, after the para's with their C-47 aircraft had moved to Marcigliana airfield North of Rome, a disappointing short range was reported during exercises. Investigation indicated that the beacon was set up in open land having a very dry soil. The 12-Inch-long earth pin, used at the previous test near the landing strip, was insufficient to obtain a good radiation. After being replaced by four counterpoise earth wires, ('Leads, Counterpoise, No. 2'), this appeared much more effective than the previous earth pin and for that reason, exact aerial matching could not be achieved. This was eventually solved by a redesign of the aerial tuning circuit.



A section of a P.S.P. (Pierced Steel Plank), also known as Marston mat.



Temporary runway constructed with P.S.P.

The Marston Mat was a standardized, perforated steel matting material developed by the United States at the Waterways Experiment Station shortly before World War II for the rapid construction of temporary runways. Large amounts of these steel planks were obviously an excellent earth, which was painfully found during the development of the Beacon Crest.

Main items SCR-269
Radio Compass.



BC-433 Radio Compass receiver.



Loop LP-21 (Cut open).



Navigator Indicator I-82.



Control Box BC-434.



Pilot Indicator I-81

The SCR-269 radio-compass was fitted in most of the USAAF aircraft during WW2. The major components shown here are not to scale of one another.

The radio compass comprised, apart from the loop aerial, receiver and two indicators, a single or a double remote control box BC-434. Only one of these control boxes functioned at one time. Homing to a beacon was uncomplicated: first, set the mode to COMPASS, then tune the receiver to the frequency of the beacon, the ID of which was known by a two- or three-letter Morse code. Turn the VAR knob on the navigator's indicator to zero azimuth. Apply rudder in the direction shown on the indicator. When the indicator was at zero, the aircraft pointed towards the radio beacon. Due to drift caused by wind, the flight path would be a curved line. It was therefore desirable to fly a straight line by offsetting the aircraft's heading to compensate for the wind. Supporting paratroops jumped from their aircraft when the compass indication swung from 0 degrees to 180 degrees, i.e. when the aircraft flew over the beacon.

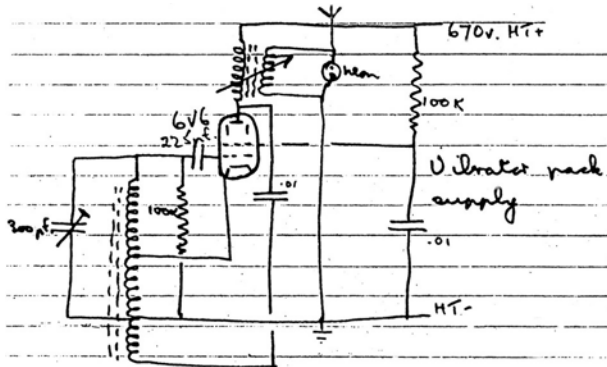

A simplified rough circuit sketch was drawn of the American unit brought in at the 16 Base REME workshop (located in Southern Italy) with a very limited range and no recognition tone. Note the absence of a crystal and the 100k resistor being not connected to the control grid in this circuit.

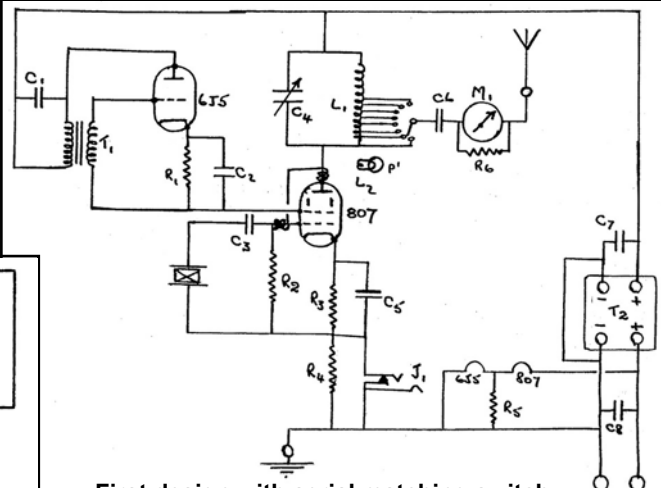

First design with aerial matching switch, RF Ammeter and ground pin.

BEACON CREST TYPE 'A'.

- LIST OF COMPONENTS.
- C.1 .006 MFD. 350V. MICA.
 - C.2 .1 MFD. 500V. PAPER TUBULAR.
 - C.3 .001MFD. 350V. MICA.
 - C.4 160PFD. VARIABLE AIR DIELECTRIC.
 - C.5 .01 MFD 350V. MICA.
 - C.6 .01 MFD 500V. MICA.
 - C.7 .1 MFD. 1,500V. PAPER TUBULAR.
 - C.8 .1 MFD. 500V. PAPER TUBULAR.
 - R.1 1,000 OHMS 1/2 WATT.
 - R.2 100,000 OHMS 1/2 WATT.
 - R.3 500 OHMS 10 WATT.
 - R.4 1,100 OHMS 2 WATT.
 - R.5 10.5 OHMS 5 WATT.
 - R.6 18 OHMS 2 WATT.
 - L.1 60 TURNS 28D.S.C. ON 1 INCH FORMER TAPPED AT 25, 30, 35, 40, 45, 50, & 55 TURNS.
 - L.2 1 1/2 TURNS BARE 20 SWG 3/4 INS. DIA INSIDE L.1.
 - T.1 TRANSFORMER A.F. NO.1.
 - T.2 TRANSFORMER ROTARY H.T. NO.1 32 WATT.
 - J.1. TELEPHONE JACK WITH SHORTING CONTACTS.
 - P.1. 6 VOLT 60 MA. LAMP.
 - M.1. 1 AMP H.F. AMMETER (THERMOCOUPLE TYPE)
 - X.1. CRYSTAL.
 - 6J5 AUDIO OSCILLATOR.
 - 807 R.F. OSCILLATOR AND OUTPUT.

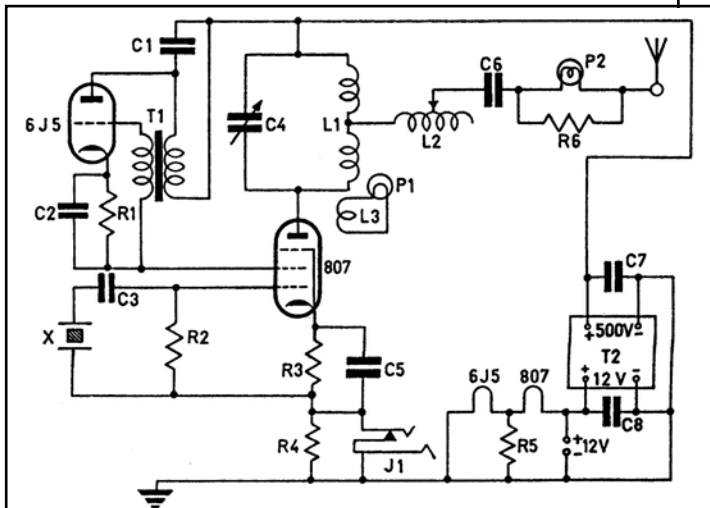

Final design with variometer matching. For the component list see page 8.

The 1A H.F. thermocouple Ammeter with an on/off switch, shown in the photo on page 2 and in the replica, was not drawn in this circuit. It is not clear if the meter was included in the prototype only, or still fitted as the metalwork was already made.

Slightly confusing was coil L2, drawn in the circuit diagram above as a variable inductor, stated as a variometer in the text, but noted in the components list as a single 120 turns copper wire on a 1-in former. A miniature home-made variometer was actually fitted in the replica.

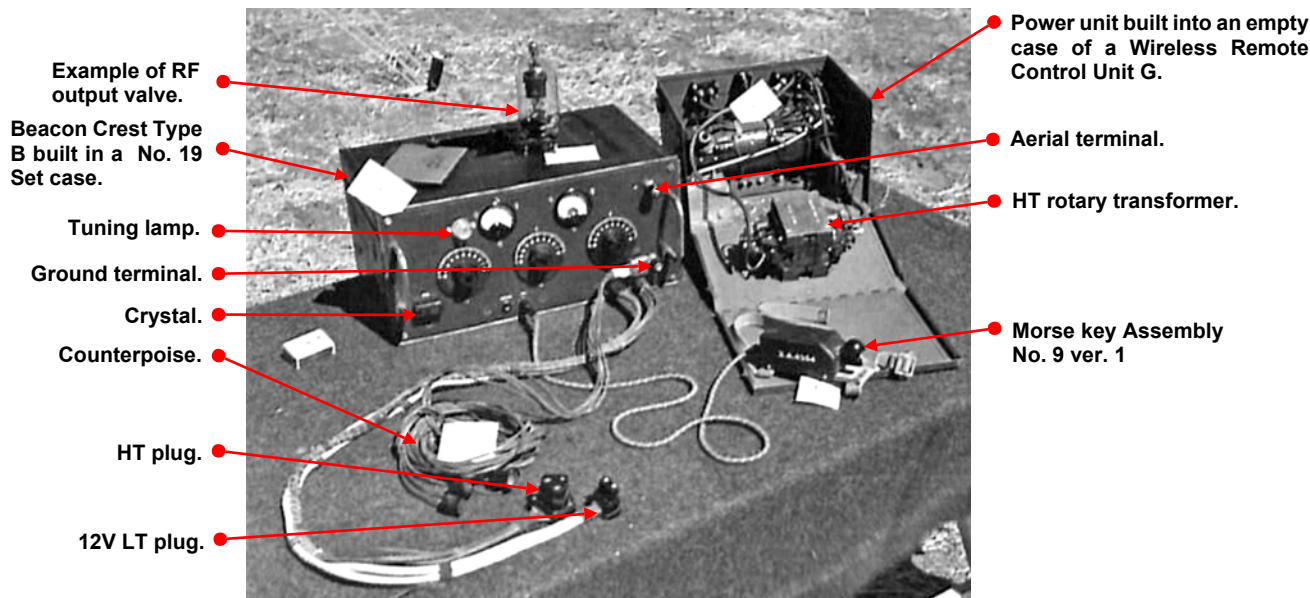

Example of RF output valve.
 Beacon Crest Type B built in a No. 19 Set case.
 Tuning lamp.
 Ground terminal.
 Crystal.
 Counterpoise.
 HT plug.
 12V LT plug.

Power unit built into an empty case of a Wireless Remote Control Unit G.
 Aerial terminal.
 HT rotary transformer.
 Morse key Assembly No. 9 ver. 1

Beacon Crest Type B. Photo IWM NA 18602.

The design chosen for the larger type B beacon for use in the invasion of Greece which required an output of 60 watts output power used a beam power tetrode driven by a 6V6 oscillator with a 6V6 modulating the screen of the output valve. It was powered by a separate motor generator fitted in an empty case of a Remote Control Unit G, driven by a 12V accumulator.
 [Source: Diary C.E. Ramsbottom].



Beacon Crest Type B in operational use. Photo IWM NA 18611.

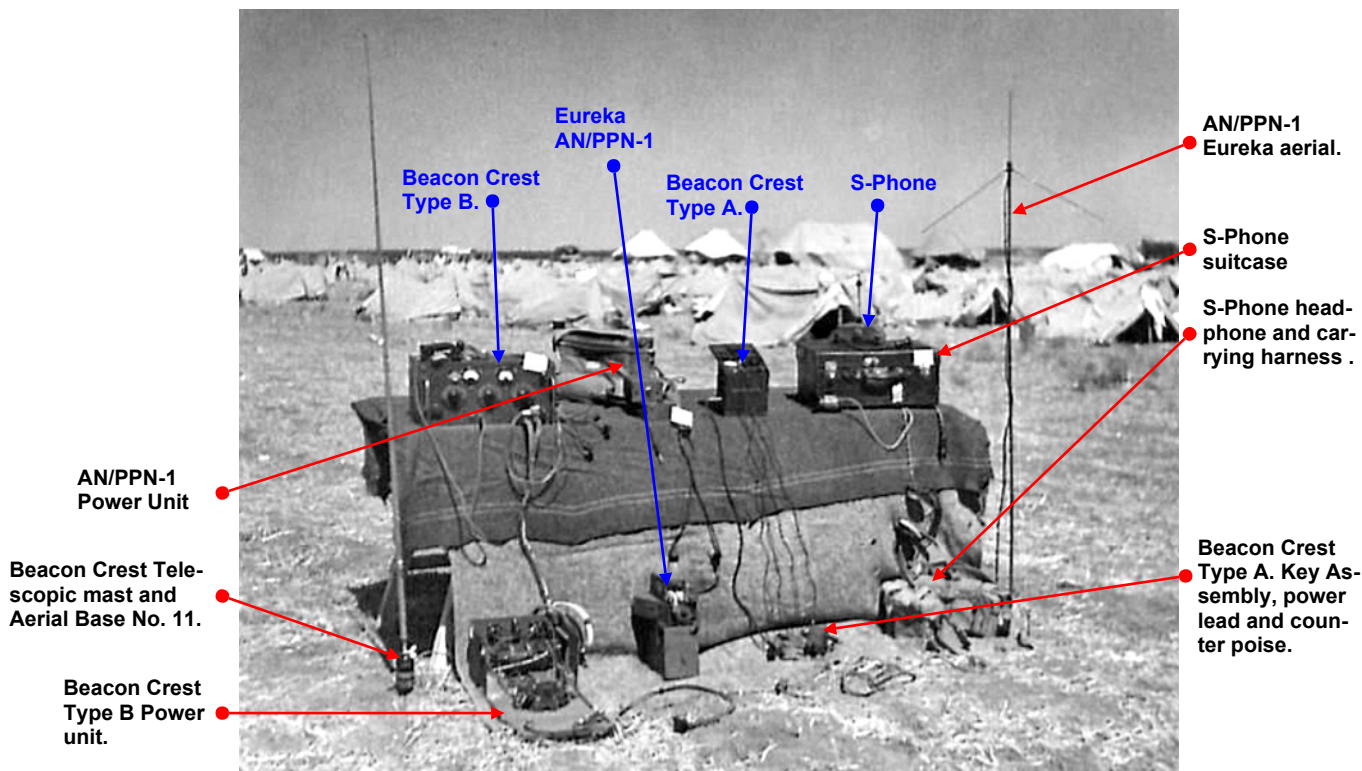

Photograph showing 4 different drop zone ground beacons. Photo IWM NA 18603.

© This WftW Various series essay is a download from www.wftw.nl. It may be freely copied and distributed, but only in the current form.

Details of the Beacon Crest Type A replica.

Building a working replica for the 80-Meter 'Ham' band. Considering the author's limited resources of building, particularly metal work, Jan Poortman, PA3ESY, living in the East of Holland was approached to build a working replica of a Beacon Crest Type A. Jan, who is known as an excellent builder of replicas and other electronic projects, agreed and immediately started gathering original period components for this project. The whole process of the making can be found on his website at: <https://www.pa3esy.nl>

On 12-08-2024, a first successful CW contact with the Beacon Crest replica was established between Jan's location in Goor and the author (PA0PCR) at Ottersum on 3580kHz, a distance of nearly 100km. It would not be surprising that building a Beacon Crest Type A replica found many followers within the amateur radio community.



Inside hinged lid with working instructions.

Original, still unmodified Spare Valves Case No. 4G. This was a later issued universal model for either WS No. 19 or No. 22. It replaced the original spare valve boxes.



An overview of all the known spare valve cases can be found as a free to download publication entitled 'WfW Pamphlet No. 6' at www.wftw.nl/downloads.html



Rearview of the Beacon Crest Type A replica showing the tuning lamp P1 and the earth terminal.

Left-hand side view of the Beacon Crest replica Type A showing the key jack socket and 12V DC input socket.

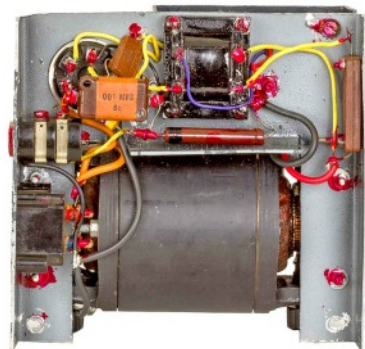
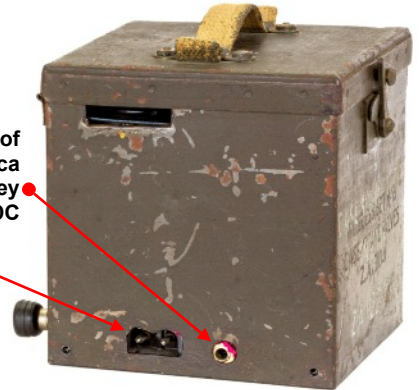

Underside chassis view of main assembly replica Beacon Crest Type A.

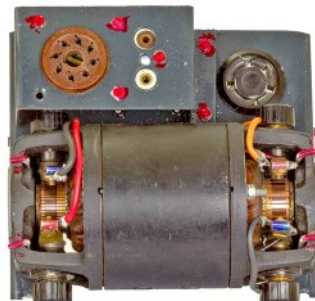

Top chassis view of main assembly replica Beacon Crest Type A.



Left-hand side view of main assembly replica Beacon Crest Type A.

After discussion, the final design was to be equipped with two indicator lamps, one for tuning and the other for aerial loading. Aerial Ammeters were considered too delicate to be incorporated for this type of service, but would still be carried and connected if required by a switch on the front panel.
(Source: Diary C.E. Ramsbottom).

Aerial matching lamp P2.

Aerial current meter.

Aerial terminal.

Meter on/off switch.

807 valve.

Tuning lamp P1.

RF output tuning control.

Aerial matching control.

Crystal.

6J5 valve.

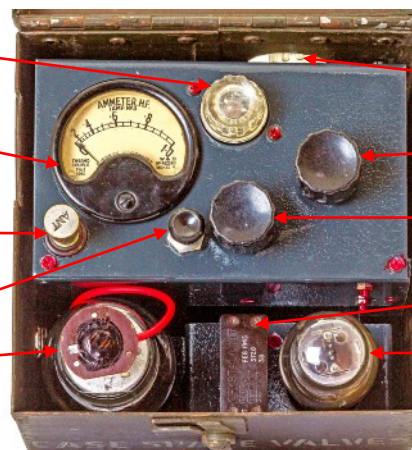

Function of controls Beacon Crest Type A.

Appendix 1: Reprint of the original article.

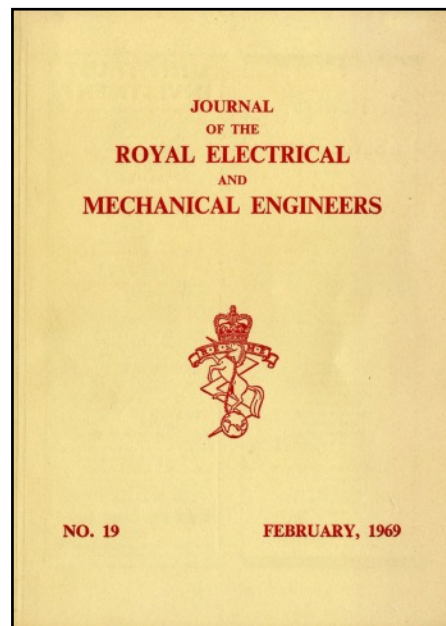

'Beacon Crest'

BY CECIL E. RAMSBOTTOM, C.ENG., M.I.E.E., M.I.E.R.E.

At the time of the project which this short story describes, the author was an Armament Artificer (Radio) in 16 Base Workshop REME, Italy; he is now Senior Lecturer in Educational Technology at Wolverhampton College of Technology. He has kindly presented to the Corps Museum his working papers and circuit diagrams, and his personal diary extending over the period 6th June—5th October, 1944, relative to this project and its outcome—Editor.

THE Instrument, Wireless and Radio Workshops, comprising "G" Section of 16 Base Workshops, moved to Pontecagnano, six miles south of Salerno, Italy, early in 1944 and were quickly accommodated, mainly in a tobacco warehouse of cathedral-like proportions and with large glass windows. The first task of the Wireless and Optical Section was to check and service equipment received from England for despatch to the forward troops, then about 100 miles to the north.

News of the Normandy landings on Tuesday, June 6th, was coupled with speculation as to the possibility of another landing in the South of France. Indeed, the 23rd Independent Paratroop Platoon, also stationed in Pontecagnano, were confident that they would be the first to land, as they had been on previous occasions in other areas.

I met one of their members, Private Eric A. Morley, in the N.A.A.F.I. in Salerno one evening in June, and as he was responsible for the paratroopers' signal stores I was not surprised when he visited me in the wireless workshop one evening when I was on duty. When I had repaired the faulty headset which he had brought with him, the workshop junk box provided him with a bonus assortment of plugs, sockets, screws and other useful replacements for his equipment.

Inevitably known as 'Curly' because of his mass of hair, this was the first glimpse of him which caught my eye on the morning of 4th July, as he marched between the row of benches to my workshop.

Placing a steel case on my desk he confided that it contained a radio beacon, and explained that when on operations their platoon flew in American aircraft which carried excellent navigators who told them when to jump. On landing, their main task was to rendezvous, locate suitable

dropping zones for the main paratroop force and then set up the radio beacons. These transmitted a signal which could be picked up by aircraft and gliders carrying the main force. All these aircraft carried a radio compass, its needle pointing to 0° as they flew towards the beacon and swinging round to 180° when they passed directly overhead, this being the signal for the main force to jump. This technique had been successful on previous occasions in Sicily and southern Italy, but there was some doubt if the beacon such as he had brought would be adequate if it was required in southern France. Could we help?

The problem was discussed with Captain P. N. Davies, REME, in charge of the workshop, and together we examined the beacon. It seemed unbelievable that such a simple, almost crude device, and bearing evidence of repair by unskilled hands, could be a vital link in the successful conduct of a large-scale airborne invasion. It consisted of a simple transmitter, using a single valve, type 6L6, in a crystal controlled oscillator circuit, and having provision for sending morse as an identification signal. Its range was about twelve miles.

Our customers lost no time in getting official approval for their project, from Allied Forces Headquarters at Caserta, and on 8th July we were instructed to design and manufacture twelve new and improved beacons. At a meeting the next day with officers of The Parachute Regiment, the following specification was decided upon:

- a. The output power to the aerial must exceed that in the current model.
- b. The modulation should be a distinct tone which could be easily identified by the aircraft.
- c. The complete station, including a twelve-volt accumulator and aerial, should be capable of being carried by one man when descending by parachute.
- d. The frequency range was to be from 1.6 MHz to 2 MHz.
- e. An indication that the beacon was radiating a signal should be incorporated.

Staff Sergeant Terry Smith and myself were detailed to undertake the project, and we were made very aware of the urgency, being told that it would be used in Southern France in the very near future.

By the following day a design had been formulated, on the basis that a transmitting valve type 807 would give sufficient output with a high tension supply of 500 volts. This could be obtained from a Rotary Transformer 32 watt, No. 1, which required 12 volts input. Very conveniently, these components could be mounted in the spare valve case which was supplied for use with Wireless Set No. 19. These cases measured 6 inches wide, $5\frac{3}{4}$ inches deep and $6\frac{1}{2}$ inches high, and could be conveniently carried in a parachute descent. They were particularly strong and, like the other main components, fairly easy to obtain.

The paratroopers were pleased with our proposals and within two days the prototype was working, so a mechanical design was agreed and a small production line organized.

All voltages and currents were checked and a few components repositioned to improve heat dissipation, so that production could go ahead. The most serious remaining problem was in the aerial circuit as the rod aerials were twelve feet long, only a fiftieth of the wavelength. Anything longer or more complicated would be almost impossible to erect immediately after landing, so it was essential to have effective aerial coupling. The simplest circuit to manufacture, a tapped anode coil, was the most difficult for the operator to adjust, and as all available aerial variometers were much too large, the only alternative was to make one.

A hectic afternoon, evening and night saw Terry Smith and myself making variations of tapped coils and home-made variometers. By early morning we had decided in favour of a variometer, as this would give the simplest tuning procedure when setting up the beacon after landing.

Craftsman Walter Pollard, who had been brought into the project, arrived at the workshop and took over reassembly whilst we went for breakfast. This enabled us to have everything ready for a flying test in the afternoon, when, to the paratroopers' delight, the beacon made contact at a range of 45 miles. It was officially named "Beacon Crest" on the airstrip after landing, by combining Terry Smith's initials (T.R.S.) with my own (C.E.R.).

Ten days after the initial enquiry the design was complete, production was going ahead and the redoubtable 'Curly' arranged to be the first to jump with the prototype beacon, which was delivered on 19th July.

Allied Forces captured Rome about this time and The Parachute Regiment moved to Marcigliana airfield near there, where their aircraft had assembled. The invasion seemed imminent, and we were urged to speed production.

We were very surprised to see on 23rd July, a paratroop officer, followed by a downcast 'Curly', carrying the beacon back to us. "Beacon Crest," he reported, was not performing as well as their original model, so, with only a few minutes to collect tools, instruments and small kit, I flew back to Rome with them.

The next morning it was fairly easy to diagnose the trouble; previous flight tests had been made with the beacon near to a metal landing strip, but here near Rome the beacon was in use in open country; furthermore, the weather was much hotter and the simple twelve inch earth spike was ineffective in baked soil.

I planned to use two thermocouple meters to measure aerial and earth currents, but one, a 1 amp. non-tropical model, had a zero error up to ½ amp. in the hot sun. The effect of various earth

systems was therefore judged by comparing the magnitude of the radio frequency 'burn' when the chassis was touched with the hand, with the new value of aerial current when the chassis was held. As this detuned the anode circuit and because the ammeter readings were considered unreliable, the nearest distance a hand could be brought close to the aerial to cause a fall in current was also recorded.

The best results were obtained with four counterpoise earth wires, each twenty feet long, and as the paratroopers did not consider this inconvenient, it was recommended for use in operations. Unfortunately, it was more effective than the earth used when we had worked through the night designing the coupling circuits, and more turns would now be needed on the variometer. Late in the day a flying test disclosed a maximum range of only 25 miles.

To avoid using aircraft for tests, the next day we fitted a wireless receiver R109 with a four foot aerial into a 15 cwt. truck. It could not receive

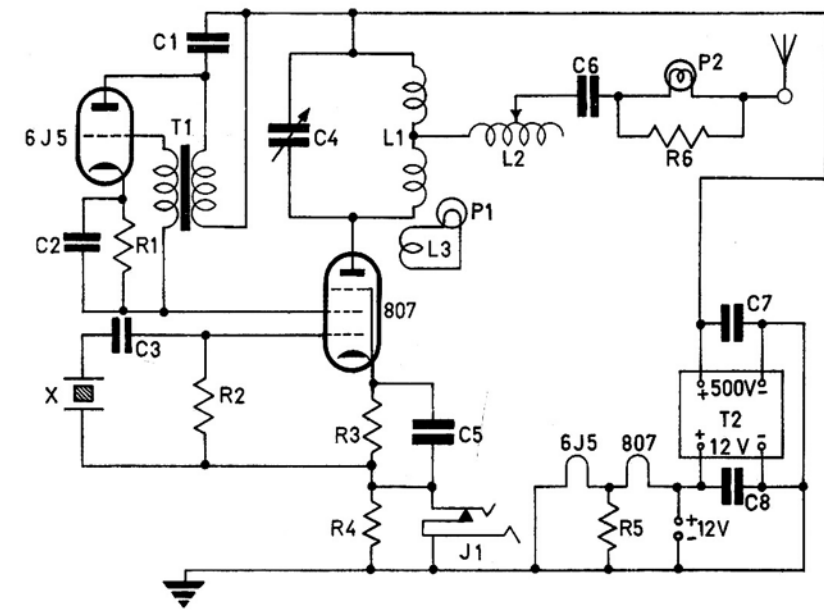

- | | |
|------------------------------|--|
| C1 6nF, mica 350V | L1 28+24 turns No. 28 DSC copper wire pile wound on 1-in. former |
| C2 100nF paper tubular 500V | L2 120 turns No. 26 enamelled copper wire on 1-in. former |
| C3 1nF mica 350V | L3 2 turns bare No. 20 copper wire, ½ in. dia., inside L1 |
| C4 Variable 160pF | J1 Telephone jack with shorting contacts |
| C5 10nF mica 350V | P1 4V 0.3A bulb |
| C6 10nF mica 500V | P2 4V 0.3A bulb |
| C7 100nF paper tubular 1500V | T2 Rotary transformer 32W No. 1 12V DC to 500V DC |
| C8 100nF paper tubular 500V | X Quartz crystal |
| R1 2.2k Ω 1W | |
| R2 100k Ω ½W | |
| R3 500 Ω 10W | |
| R4 1k Ω 2W | |
| R5 10.5 Ω 5W | |
| R6 18 Ω 2W | |
| T1 Transformer AF No. 19 | |

C=Capacitor R=Resistor

Wiring Diagram and Component List—"Beacon Crest", Type 'A'.

on the beacon frequency, so this problem was overcome by tuning to the second harmonic. One advantage was that the range was reduced and we were able to save time in getting reports back via a wireless set No. 38. In the afternoon some modifications were carried out, showing an improvement in range during a flying test we were able to arrange later in the day.

The American air crews now became very interested in the project, and some came on one of the flights for a trial "run-in". When I mentioned that I needed to collect a new variometer, it seemed

that the whole squadron was willing to escort me. As we flew, several landing craft could be seen on exercise in the bays along the west coast of Italy, thus emphasizing the urgency of our mission.

The following day the modified beacon was tested, demonstrated and approved, so we hastened back to the workshop, to give instructions regarding the modified aerial circuit design, and the inclusion of counterpoise earths.

Whilst the beacons were being completed there was an opportunity to make a larger version, having sixty watts output, for use in Greece, where it was thought navigation would be more difficult. One of these known as type "B", was collected with the last batch of normal type "A" beacons as ours had been called, on 10th August.

The invasion of southern France took place on Tuesday, 15th August. 'Curly', fully equipped and carrying our prototype model, accumulator and accessories, was first in line to exit from the leading aircraft, but as he jumped his parachute harness snapped and he fell, being instantly killed.

It was reported to us that apart from a further beacon being put out of action by a German bullet, the remainder had brought in the main force, to land and consolidate their positions more easily than on previous occasions. Later we heard that when the larger type "B" beacon was set up in Greece on 5th October it could be received by the main force before they left the Italian mainland.

'Curly' is buried in Mazargues Cemetery Extension, Marseilles. He died fulfilling the first of his two great ambitions, as he had every intention of also being the first to jump on the invasion of Greece.

In material value the beacons cost only a few pounds each, and given more time the design could have been improved, but in spite of this the paratroopers had an instrument with electrical performance superior to that of its predecessor.

I now realize what did not occur to us at the time. By our close liaison with the troops and aircrews involved in the operation, "Beacon Crest" contained more than just a few electronic components. We had built into it not only our own confidence, but theirs as well.

24

Note: The C-43 aircraft referred to in this article was likely the Douglas C-47 Skytrain, also known as the Dakota. There was a Douglas C-43 aircraft, but it was a variant of the Douglas DC-3 airliner, which was used as a staff transport rather than a troop transport. The C-43 had limited production and was primarily used by the U.S. Army Air Forces for transporting personnel, rather than large numbers of troops like the C-47. So, while there was a C-43, it was not a dedicated troop transport aircraft like the C-47.

Acknowledgements:

- With many thanks to Celia Cassingham, REME Museum Archivist, who kindly assisted in locating the original Beacon Crest article in the Journal of the REME, arranged permission for reprint and guided the process for donating the replica shown in this WftW Various Series No. 13 to the REME museum.
- Building a working replica of the Beacon Crest Type A, which operated on the 80-Meter radio amateur band, was skilfully crafted by Jan Poortman, PA3ESY. <https://www.pa3esy.nl>

References:

- 'Beacon Crest', C.E. Ramsbottom, The REME Journal, Feb. 1969.
- REME Museum reference Beacon Crest folder A:1969.0954.
- Diary of C.E. Ramsbottom, 6th June 1944 till 15th August 1944, part of the above museum folder.
- Photo's retrieved from the IWM website: NA 18601, /02, /03, /11.
- Craftsmen of the Army, Pt. 1, Corps of REME publication, 1970.
- Instruction book, Radio Compass SCR-269-F, AAF T.O. No. 08-10-110, Sept. 1942.
- WftW Pamphlet Series No. 6, Wireless Set No. 19 spare valves cases: <http://www.wftw.nl/downloads.html>



REME Museum
Calne Road, Lyneham
Chippenham, SN15 4XX

Open Tues - Sun, 10:00 - 16:30
Last entry 15:00

01249 894869

enquiries@rememuseum.org.uk

A loose leaf folder for the WftW Pamphlet Series.

Shown right is a suggestion for a simple and inexpensive method to keep the printed pages together in a plastic clear view A4 document folder. Printable front and rear cover sheets, provided with the downloads, will give the folder an attractive appearance.

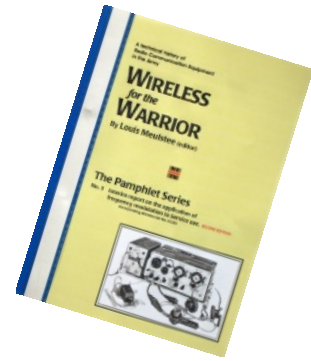

The WftW Pamphlet series

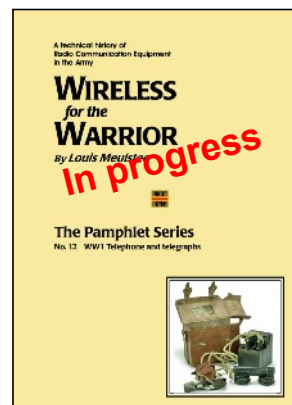
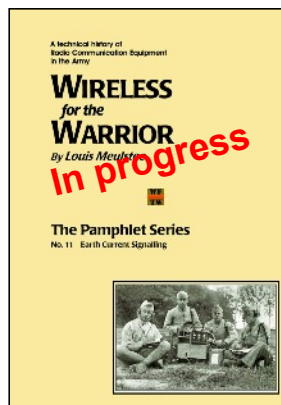
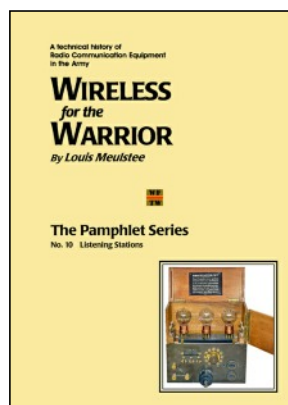
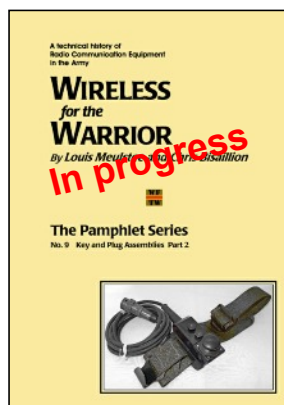
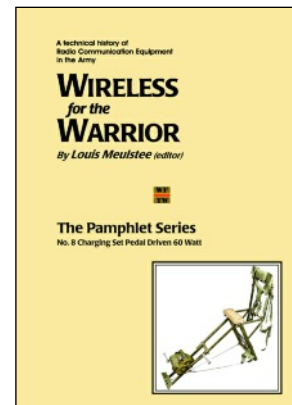
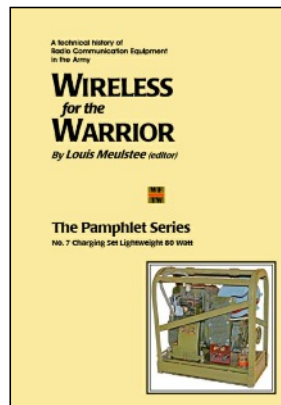
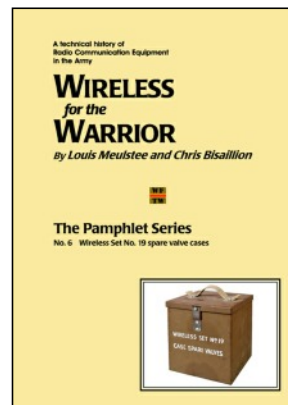
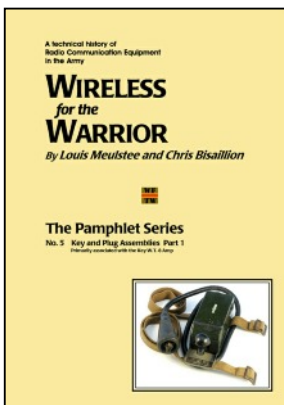
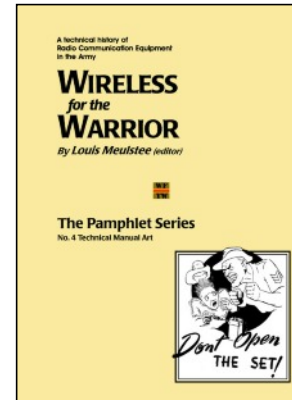
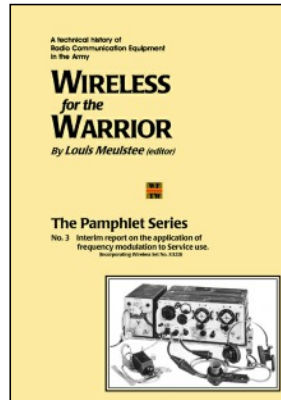
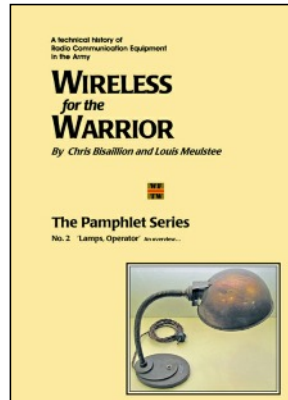
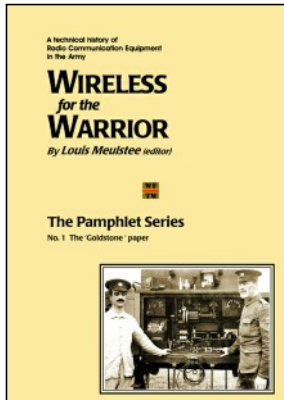

The **WftW Pamphlet** series is an addition to the **Wireless for the Warrior** range, created to accommodate a future range of reprints of articles and reports of historical importance, hitherto not published documents, and technical reports on British Army signalling. This free to download and print ready series in A4 format replaced the now discontinued 'Overview' booklets. WftW Pamphlet No. 5 replaced the earlier Compendium 7 A5 format free download and is now only available in A5 printed form and free A4 format download.

In answer to requests, WftW Pamphlet No. 4 (Technical Manual Art) is also available via 'print on demand' Lulu inc. See <https://www.lulu.com/spotlight/wftw>

About the Wireless for the Warrior books

The Wireless for the Warrior range of books (comprising the **Volume**, **Compendium**, **Supplement** and **Pamphlet** series) are intended as a source of reference to the history and development of radio communication equipment used by the British Army from the very early days of wireless up to the 1960's. Line equipment and military radio communication equipment from other countries is also covered in the recently published Compendiums. For detailed information, review pages and order information visit www.wftw.nl

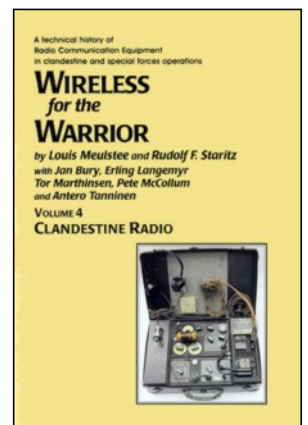
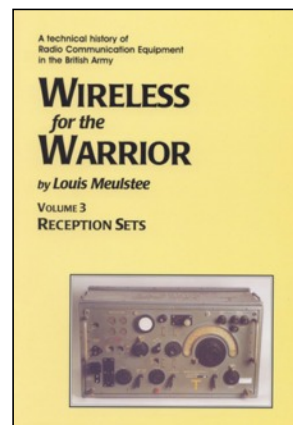
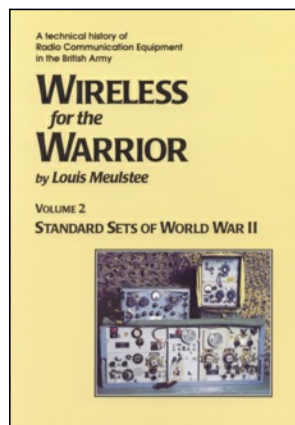
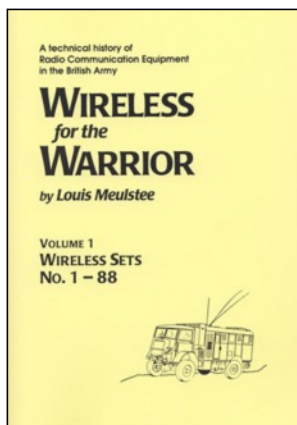

The books in the WftW **Volume** series are very detailed and include circuit diagrams, technical specifications and alignment data in addition to technical development history, complete station lists and vehicle fitting instructions. Generally no operational histories are given as these have been published extensively in numerous other books.

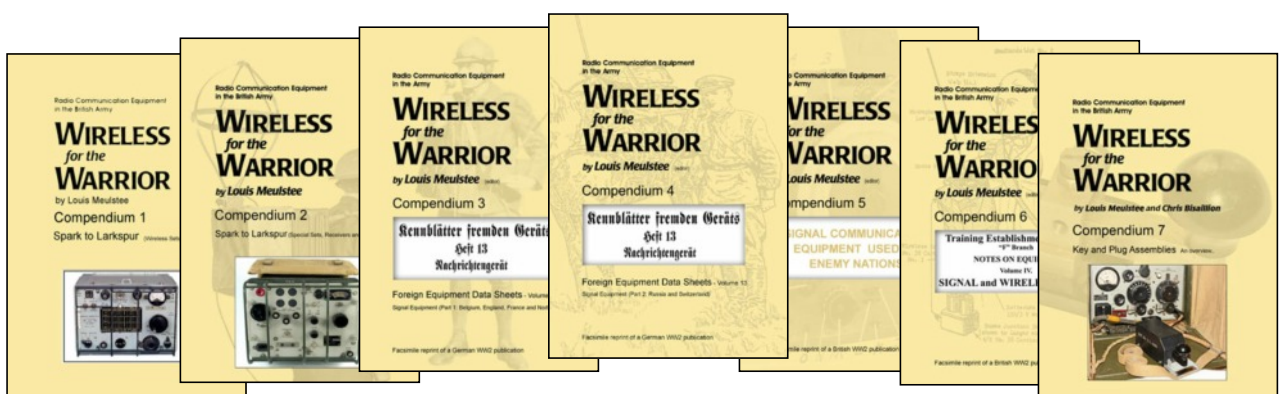

The WftW **Compendium** series is a new addition to the Wireless for the Warrior range, currently comprising 7 books. The new series is principally intended as a practical guide and reference source to vintage military signal communication equipment. The books are particularly valuable to anyone with an interest, professionally or otherwise, in this subject, requiring an elementary but complete quick reference and recognition handbook. Containing condensed data summaries, liberally illustrated with photos and drawings, explanatory captions and short description of the main ancillaries, its pocket size format and laminated soft cover makes it an ideal reference and reliable companion for events such as auctions and radio rallies, or just for browsing at leisure.

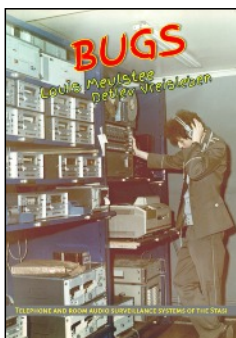

WftW **'BUGS'** is a recent book describing the technical history of telephone and room surveillance systems of the Stasi. It was written in cooperation with Detlev Vreisleben.

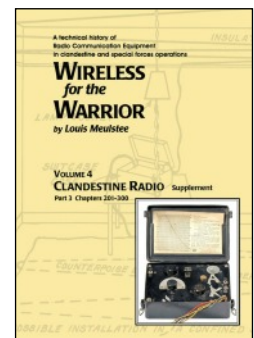
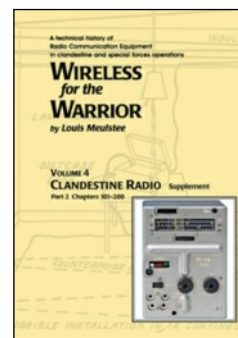
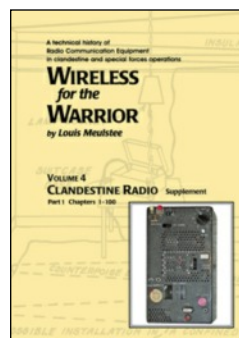

The WftW **'Supplement'** series are full colour reprints of previously published WftW Vol. 4 Supplement 'Chapters'.